



## Thule XT Kit 3017

# > Instructions

**CITROËN C5**, 4-dr Sedan, 08-

**CITROËN C6**, 4-dr Sedan, 05-12

**PEUGEOT 207**, 3-dr Hatchback, 06-12

**PEUGEOT 207**, 5-dr Hatchback, 06-12

**PEUGEOT 308**, 3-dr Hatchback, 07-13

**PEUGEOT 308**, 5-dr Hatchback, 07-13

**PEUGEOT 407**, 4-dr Sedan, 04-10

**PEUGEOT 3008**, 5-dr SUV, 09-16

**PEUGEOT 5008**, 5-dr MPV, 09- (Without integrated railing)

This kit is only for vehicles with fixpoint mounting.

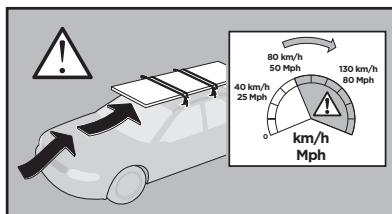
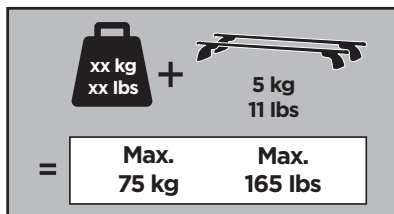
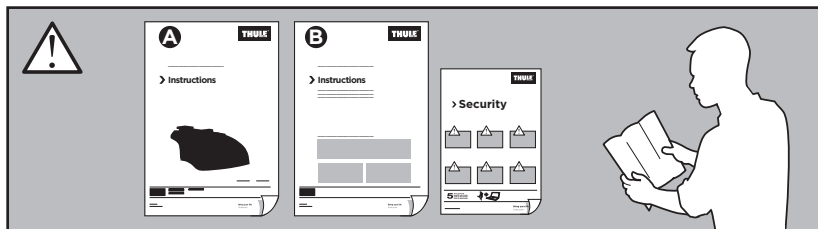

ISO 11154-E

183017

C.20170130  
509-3017-06

Bring your life  
thule.com

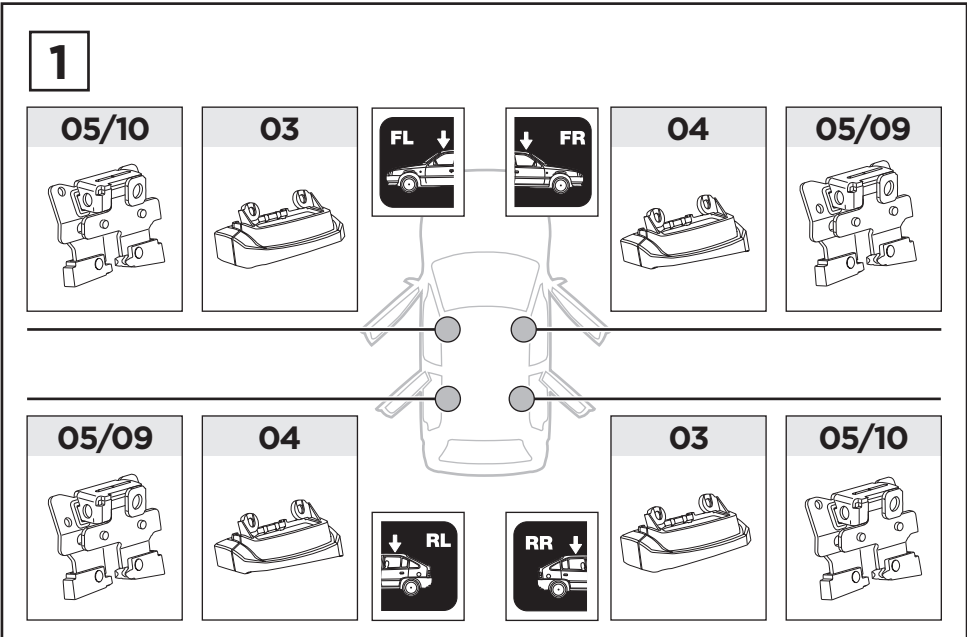
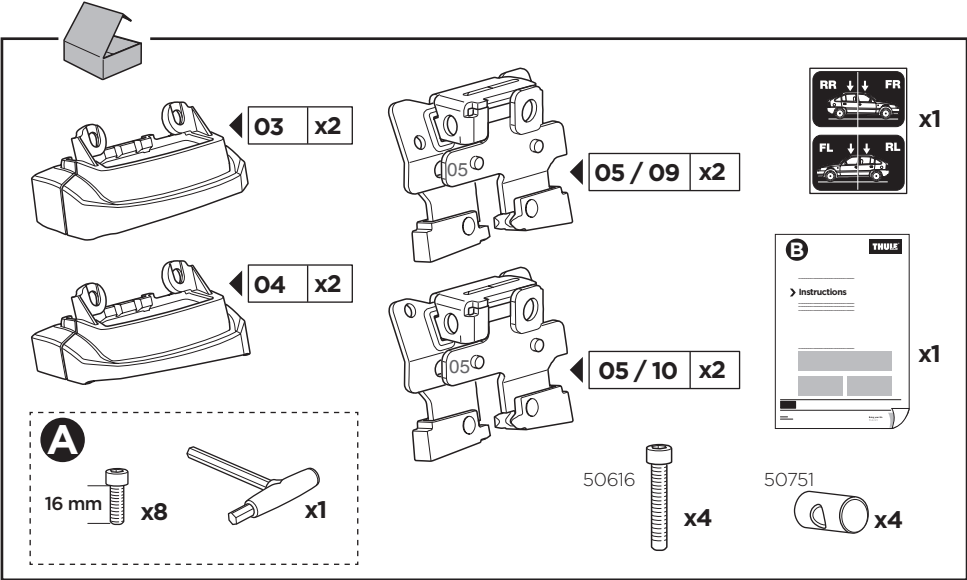
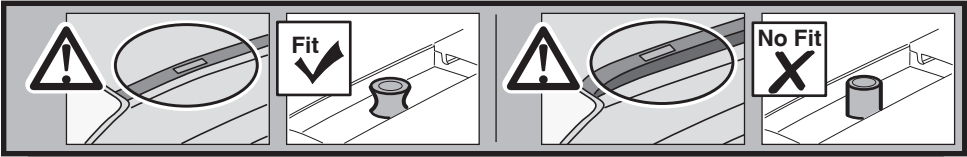

2

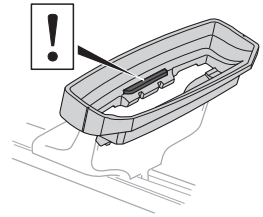
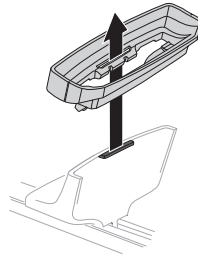
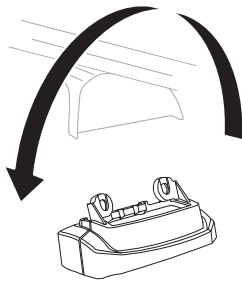

A

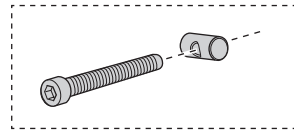
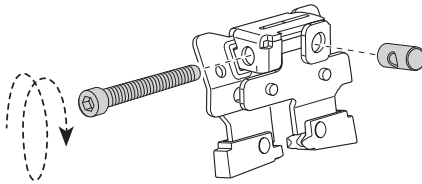

B

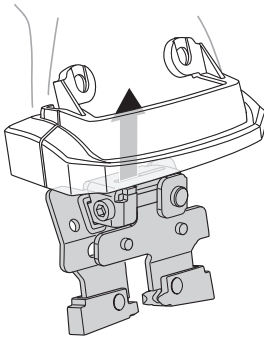

C

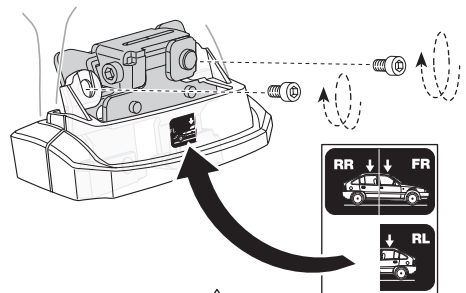
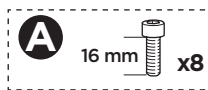

**EN** Only a few turns  
**DE** Nur wenige Umdrehungen  
**FR** Quelques tours uniquement  
**NL** Slechts enkele slagen  
**IT** Solo qualche giro  
**ES** Sólo algunas vueltas  
**PT** Noções básicas  
**SV** Endast några varv  
**DK** Kun nogle få omgange  
**NE** Bare noen få omdreinger  
**FI** Vain muutama kierros

**ET** Ainult mõni pööre  
**LV** Tikai dažī apgriezieni  
**LT** Tik keli pasukimai  
**PL** Wystarczy kilka obrotów  
**RU** Только несколько оборотов  
**UK** Лише декілька обертів  
**BG** Само няколко завъртания  
**CS** Pouze několik otáček  
**SK** Len niekoľko otáčok  
**SL** Le nekaj obratov  
**HR/BIH** Samo nekoliko okreta

**RO** Doar câteva rotiri  
**HU** Csak néhány fordítás  
**EL** Μόνο λίγες περιστροφές  
**TR** Yalnızca birkaç tur  
**AR** بعض دورات فقط  
**HE** רק מספר סיבובים  
**ZH** 仅几圈  
**JA** 2～3回転のみ  
**KO** 몇 번만 돌리면 됨  
**TH** เพียงสองสามรอบ

3

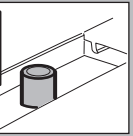
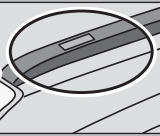
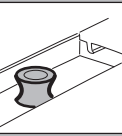
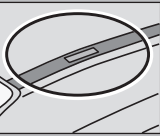
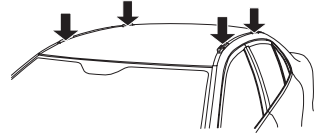

A

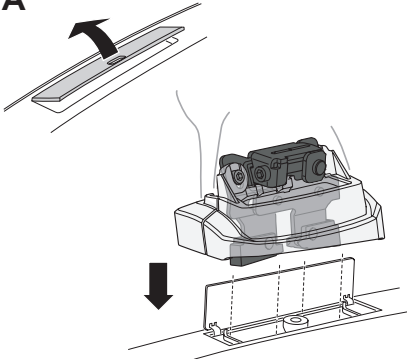

B

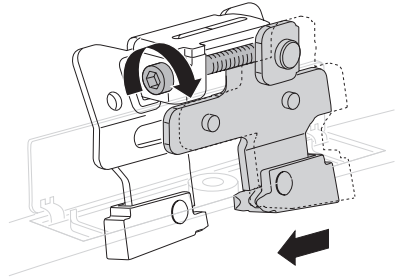

4

A

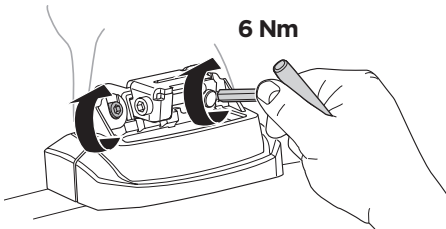
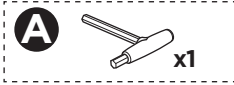

B

