



Thule XT Kit 3035

> Instructions

CITROËN C8, 5-dr MPV, 02-10

CITROËN Evasion, 5-dr MPV, 94-01

FIAT Ulyssé, 5-dr MPV, 94-01, 02-10

LANCIA Phedra, 5-dr MPV, 02-10

LANCIA Zeta, 5-dr MPV, 94-01

PEUGEOT 806, 5-dr MPV, 94-01

PEUGEOT 807, 5-dr MPV, 02-10

This kit is only for vehicles with T-profile.

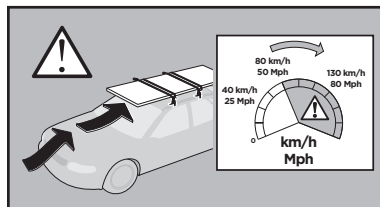
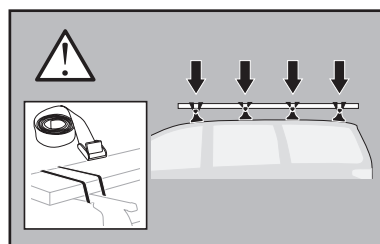
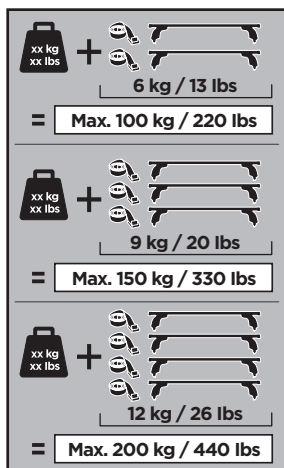
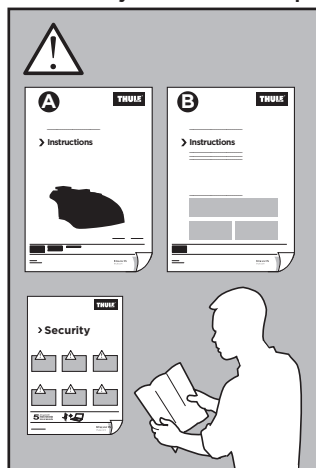

ISO 11154-E

183035

C.20130605
509-3035-03

Bring your life
thule.com

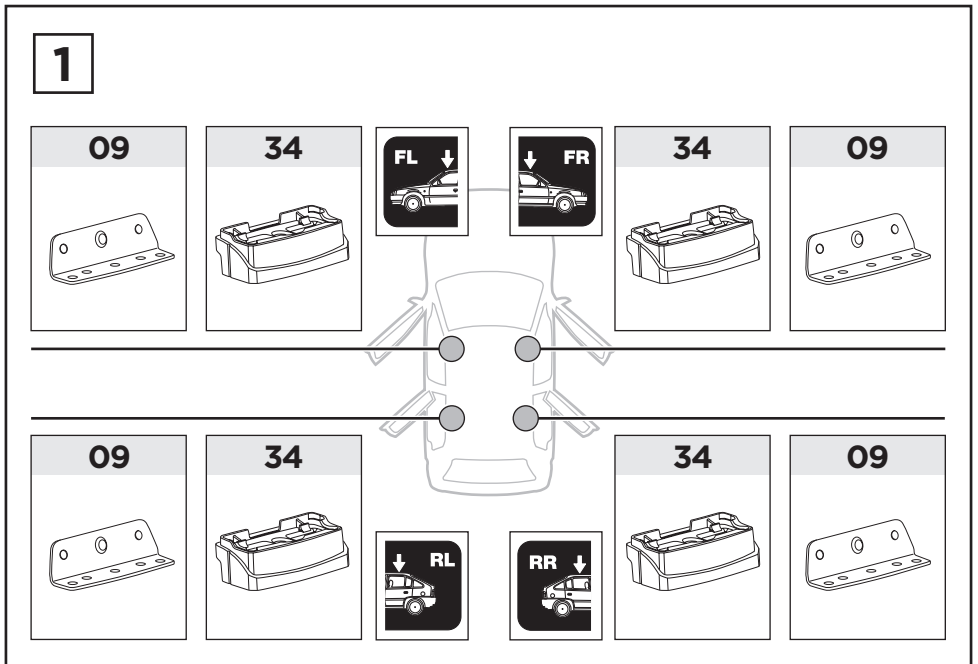
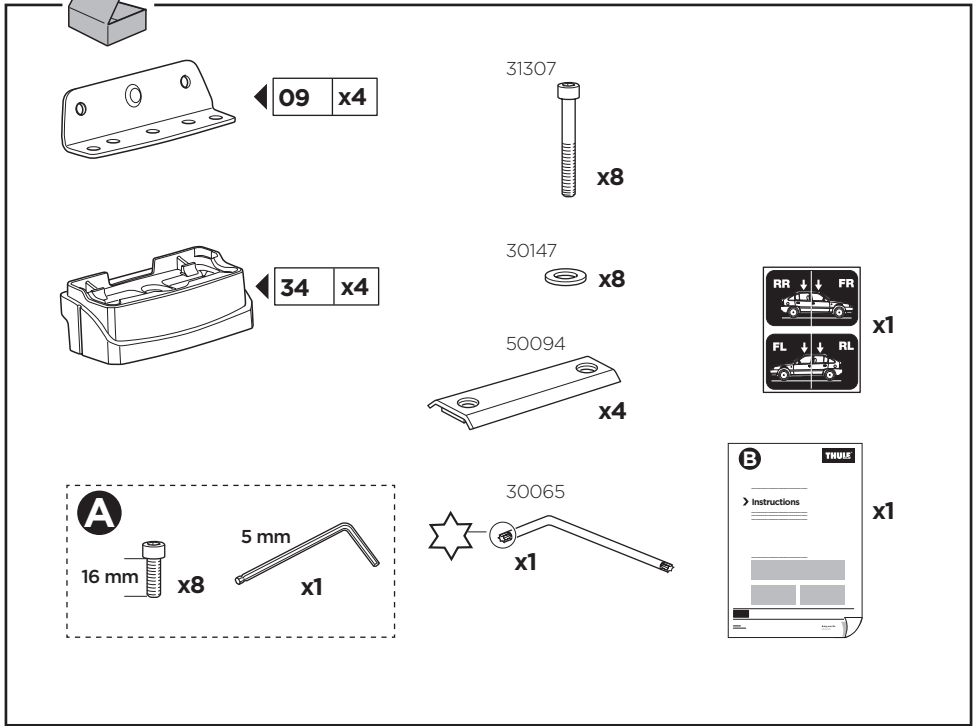

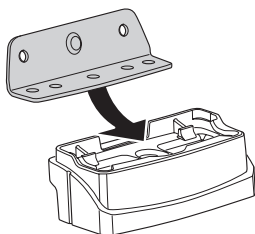
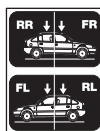
2 A**B** **A** 16 mm x8

x1

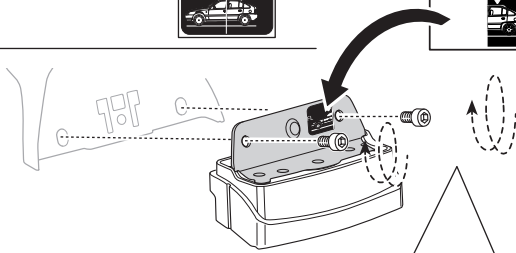
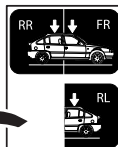
**EN** Only a few turns**DE** Nur wenige Umdrehungen**FR** Quelques tours uniquement**NL** Slechts enkele slagen**IT** Solo qualche giro**ES** Sólo algunas vueltas**PT** Noções básicas**SV** Endast några varv**DK** Kun nogle få omgange**NE** Bare noen få omdreinger**FI** Vain muutama kierros**ET** Ainult mõni pööre**LV** Tikai daži apgriezieni**LT** Tik keli pasukimai**PL** Wystarczy kilka obrotów**RU** Только несколько оборотов**UK** Лише декілька обертів**BG** Само няколко завъртания**CS** Pouze několik otáček**SK** Len niekoľko otáčok**SL** Le nekaj obratov**HR/BiH** Samo nekoliko okreta**RO** Doar câteva rotiri**HU** Csak néhány fordítás**EL** Μόνο λίγες περιστροφές**TR** Yalnızca birkaç tur**AR** بعض دورات فقط**HE** רק מספר סיבובים**ZH** 仅几圈**JA** 2～3回転のみ**KO** 몇 번만 돌리면 됨**TH** เพียงสองสามรอบ**3**

x8

x8

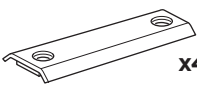

x4

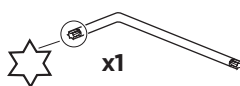

x1

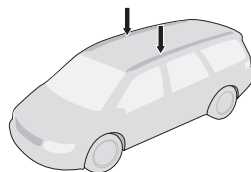
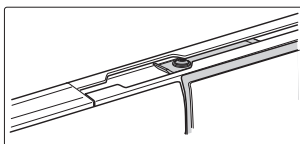
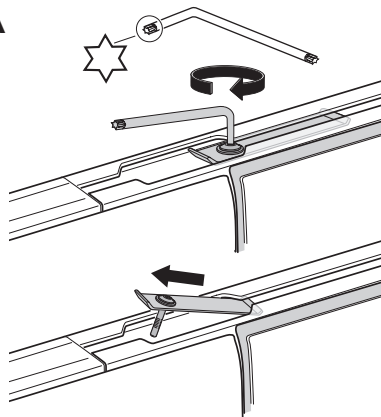
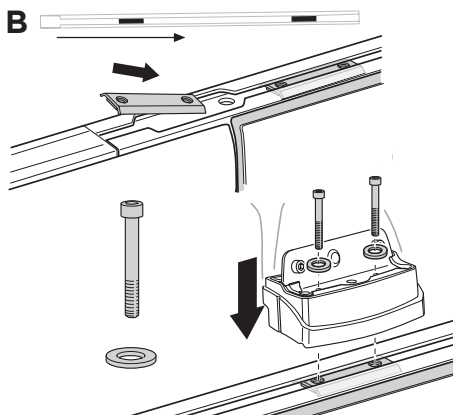
CITROËN C8, 5-dr MPV, 02-10**CITROËN Evasion**, 5-dr MPV, 94-01**FIAT Ulyssé**, 5-dr MPV, 94-01, 02-10**LANCIA Phedra**, 5-dr MPV, 02-10**LANCIA Zeta**, 5-dr MPV, 94-01**PEUGEOT 807**, 5-dr MPV, 02-10**A****B**

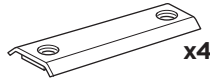
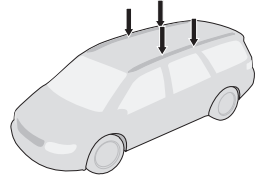
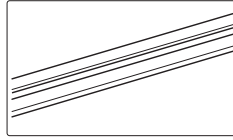
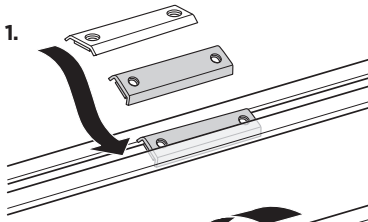
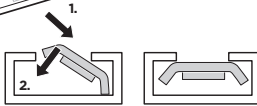
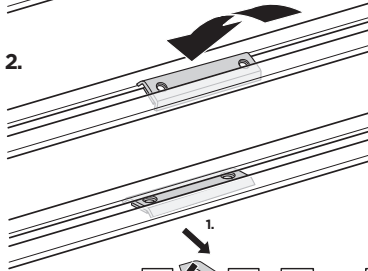
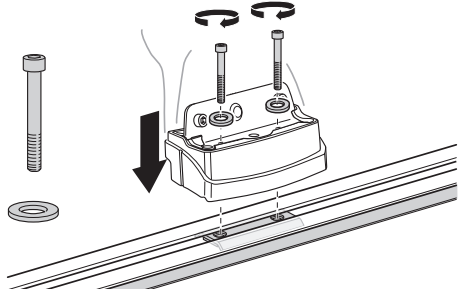
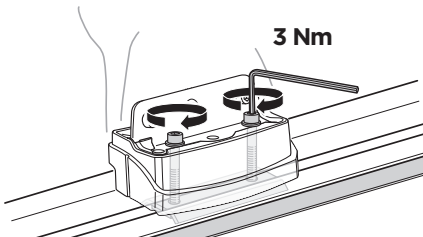
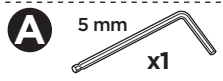
3**x8****x8****x4****PEUGEOT 806, 5-dr MPV, 94-01****A 1.****2.****B****4****A****B**