

# 1

## Kit 5063

FORD Ranger, 4-dr Double Cab, 11-  
 FORD Ranger, 4-dr Super Cab, 11-  
 MAZDA BT-50, 4-dr Double Cab, 12-  
 MAZDA BT-50, 2-dr Single Cab, 12-



ISO 11154-E

### 1 KIT

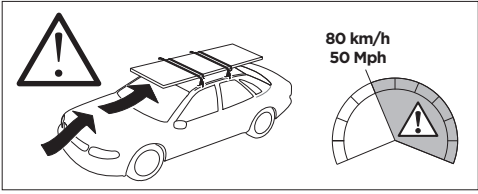
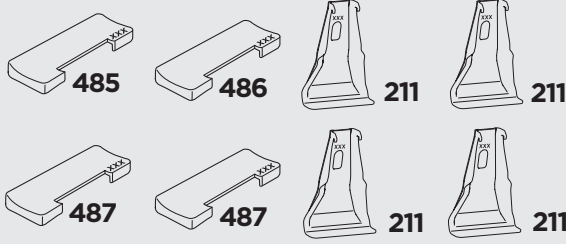
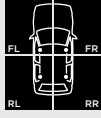

### 2 FOOT PACK

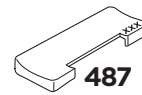
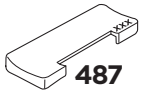
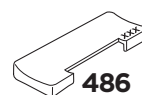
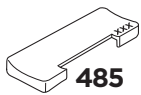
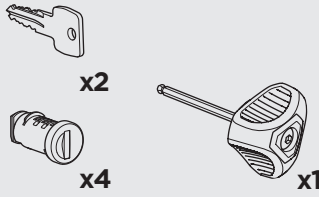
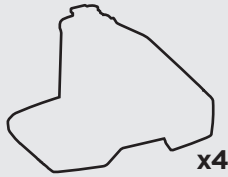

### 1



### 2

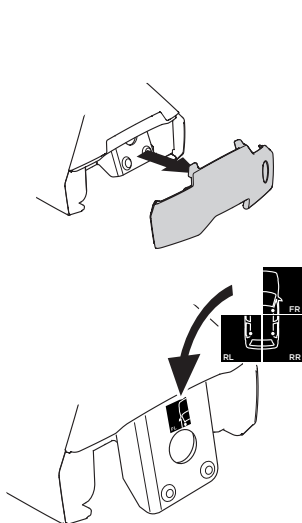

x4

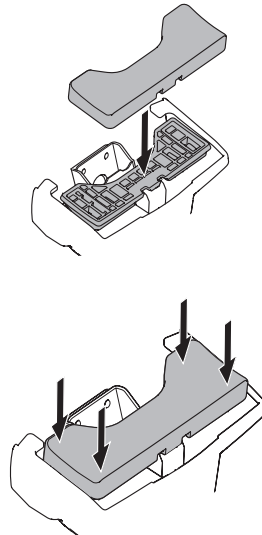

x4

### 3

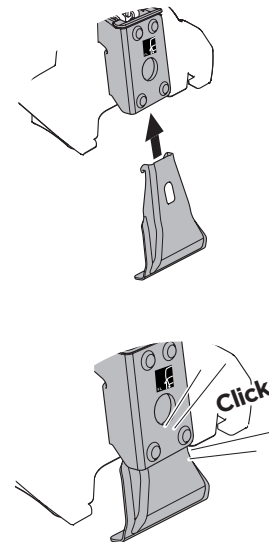

x4



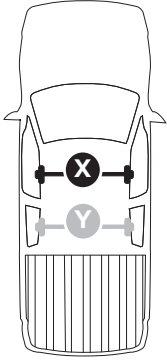

THULE WingBar Evo            THULE WingBar Edge            THULE WingBar            THULE SquareBar	Evo X (scale)	Edge X (scale)
<b>FORD Ranger</b> , 4-dr Double Cab, 11-	47	C
<b>FORD Ranger</b> , 4-dr Super Cab, 11-	47	C
<b>MAZDA BT-50</b> , 4-dr Double Cab Cab, 12-	47	C
<b>MAZDA BT-50</b> , 2-dr Single Cab Cab, 12-	47	C

THULE ProBar            THULE SlideBar	X (mm/inch)
<b>FORD Ranger</b> , 4-dr Double Cab, 11-	1121 mm / 44 1/8"
<b>FORD Ranger</b> , 4-dr Super Cab, 11-	1121 mm / 44 1/8"
<b>MAZDA BT-50</b> , 4-dr Double Cab, 12-	1121 mm / 44 1/8"
<b>MAZDA BT-50</b> , 2-dr Single Cab, 12-	1121 mm / 44 1/8"

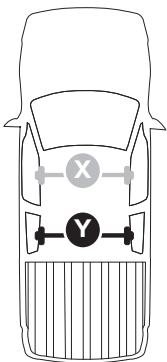

THULE WingBar Evo            THULE WingBar Edge            THULE WingBar            THULE SquareBar	Evo Y (scale)	Edge Y (scale)
<b>FORD Ranger</b> , 4-dr Double Cab, 11-	45	G
<b>FORD Ranger</b> , 4-dr Super Cab, 11-	44,5	H
<b>MAZDA BT-50</b> , 4-dr Double Cab, 12-	44,5	H
<b>MAZDA BT-50</b> , 2-dr Single Cab, 12-	-	-

THULE ProBar            THULE SlideBar	Y (mm/inch)
<b>FORD Ranger</b> , 4-dr Double Cab, 11-	1101 mm / 43 3/8"
<b>FORD Ranger</b> , 4-dr Super Cab, 11-	1096 mm / 43 1/8"
<b>MAZDA BT-50</b> , 4-dr Double Cab, 12-	1096 mm / 43 1/8"
<b>MAZDA BT-50</b> , 2-dr Single Cab, 12-	-

	W (mm/inch)	Z (mm/inch)
<b>FORD Ranger</b> , 4-dr Double Cab, 11-	700 mm / 27 1/2"	235 mm / 9 1/4"
<b>FORD Ranger</b> , 4-dr Super Cab, 11-	600 mm / 23 5/8"	185 mm / 7 1/4"
<b>MAZDA BT-50</b> , 4-dr Double Cab, 12-	600 mm / 23 5/8"	185 mm / 7 1/4"
<b>MAZDA BT-50</b> , 2-dr Single Cab, 12-	-	185 mm / 7 1/4"

