

1

Kit 145078

BUICK Regal Sportback, 5-dr Hatchback, *18-
 HOLDEN Commodore, 5-dr Hatchback, 17-
 OPEL Insignia Grand Sport, 5-dr Hatchback, 17-
 VAUXHALL Insignia Grand Sport, 5-dr Hatchback, 17-





*North America

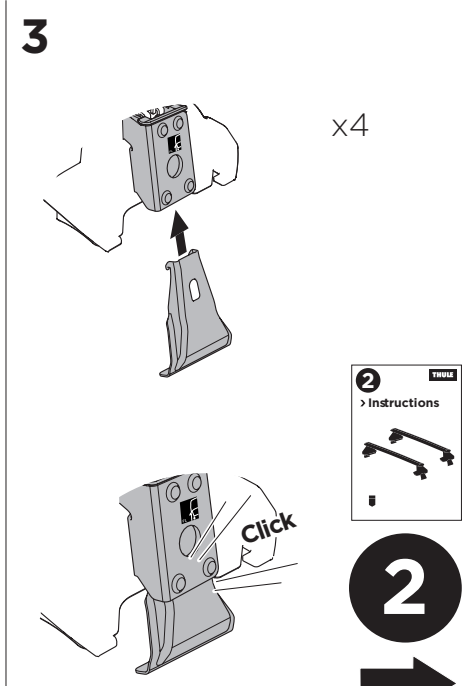
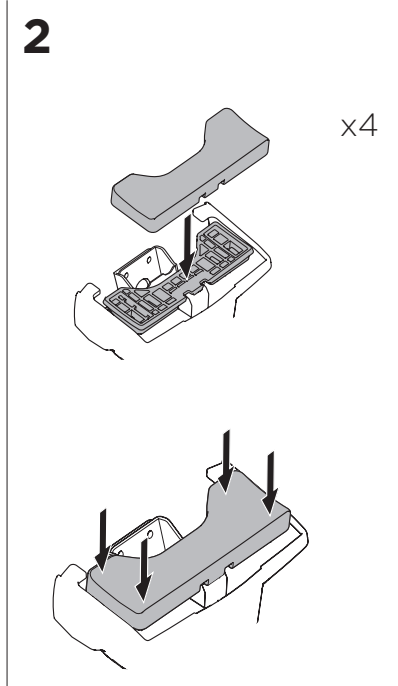
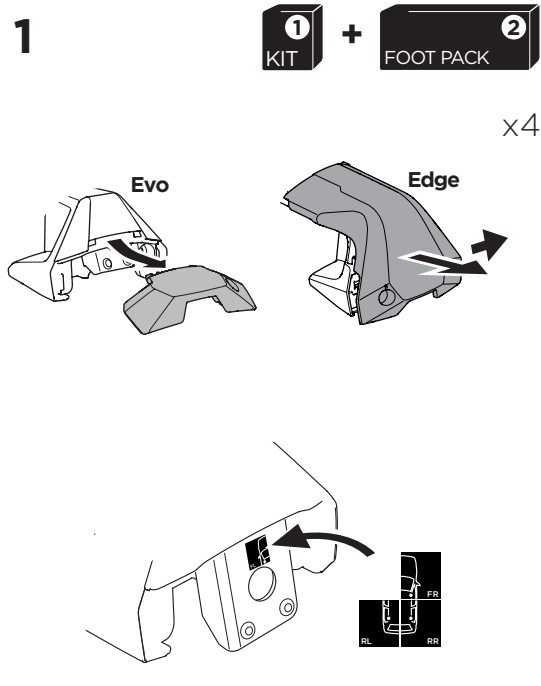
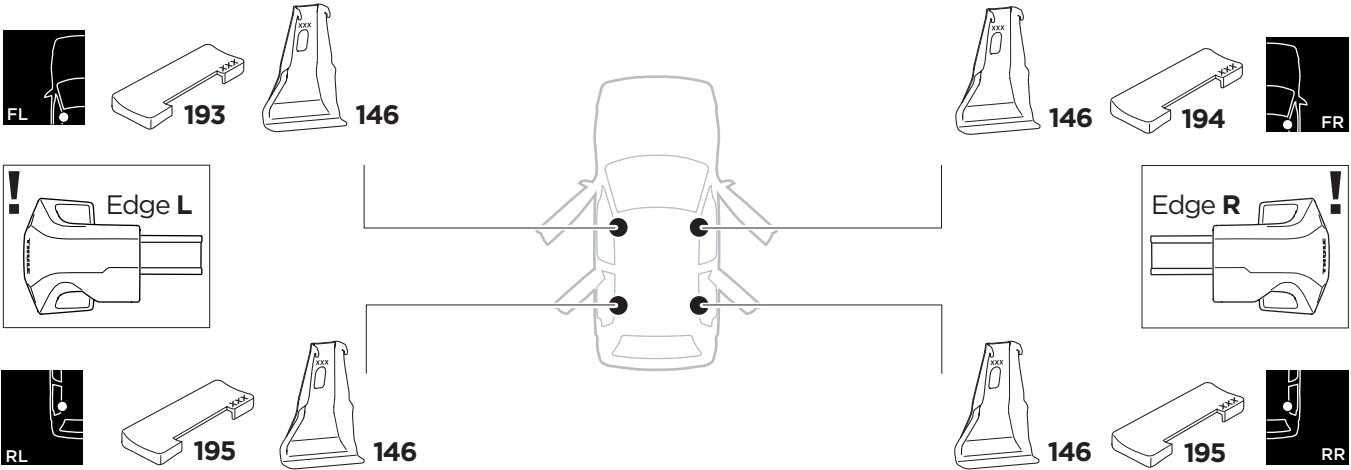
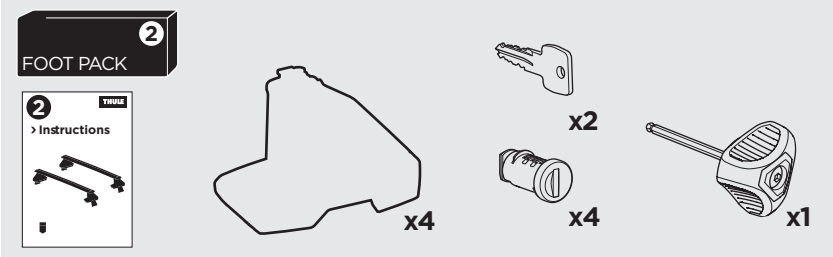
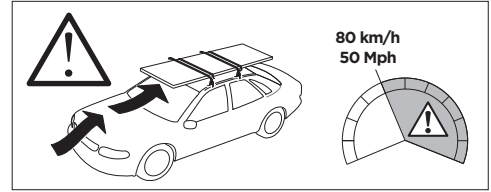
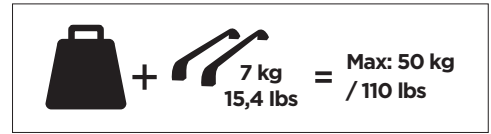
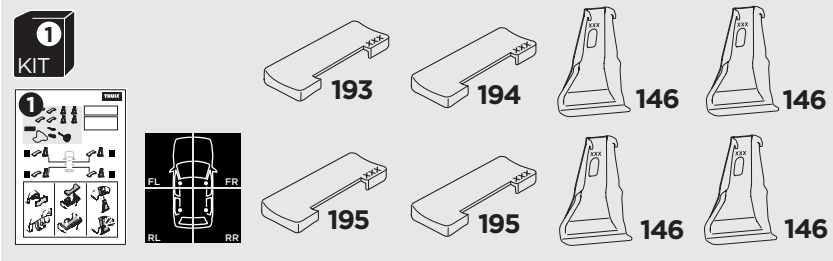

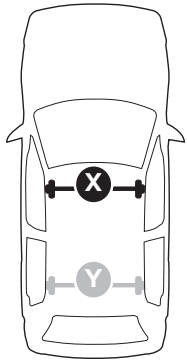

ISO 11154-E









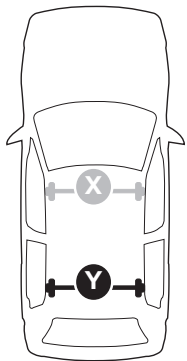

 THULE WingBar Evo  THULE WingBar Edge  THULE WingBar  THULE SquareBar	Evo X (scale)	Edge X (scale)
BUICK Regal Sportback , 5-dr Hatchback, *18-	46	E
OPEL Insignia Grand Sport , 5-dr Hatchback, 17-	46	E
VAUXHALL Insignia Grand Sport , 5-dr Hatchback, 17-	46	E

 THULE ProBar  THULE SlideBar	X (mm/inch)
BUICK Regal Sportback , 5-dr Hatchback, *18-	1111 mm / 43 3/4"
OPEL Insignia Grand Sport , 5-dr Hatchback, 17-	1111 mm / 43 3/4"
VAUXHALL Insignia Grand Sport , 5-dr Hatchback, 17-	1111 mm / 43 3/4"



 THULE WingBar Evo  THULE WingBar Edge  THULE WingBar  THULE SquareBar	Evo Y (scale)	Edge Y (scale)
BUICK Regal Sportback , 5-dr Hatchback, *18-	44	I
OPEL Insignia Grand Sport , 5-dr Hatchback, 17-	44	I
VAUXHALL Insignia Grand Sport , 5-dr Hatchback, 17-	44	I

 THULE ProBar  THULE SlideBar	Y (mm/inch)
BUICK Regal Sportback , 5-dr Hatchback, *18-	1091 mm / 43 "
OPEL Insignia Grand Sport , 5-dr Hatchback, 17-	1091 mm / 43 "
VAUXHALL Insignia Grand Sport , 5-dr Hatchback, 17-	1091 mm / 43 "

	W (mm/inch)	Z (mm/inch)
BUICK Regal Sportback , 5-dr Hatchback, *18-	730 mm / 28 3/4"	140 mm / 5 1/2"
OPEL Insignia Grand Sport , 5-dr Hatchback, 17-	730 mm / 28 3/4"	140 mm / 5 1/2"
VAUXHALL Insignia Grand Sport , 5-dr Hatchback, 17-	730 mm / 28 3/4"	140 mm / 5 1/2"

